



EMERSON[™]
Industrial Automation



1040 ... 1640 kVA - 50 Hz
1300 ... 2000 kVA - 60 Hz

4098 en - 2011.03 / d



PARTNER ALTERNATORS

LSA 50.2 - 4 Pole

Electrical and mechanical data

SPECIALY ADAPTED FOR APPLICATIONS

The LSA 50.2 alternator is designed to be suitable for typical generator set applications, such as: backup, base production, cogeneration, marine applications, rental, telecommunications, etc.

COMPLIANT WITH INTERNATIONAL STANDARDS

The LSA 50.2 alternator conforms to the main international standards and regulations:

IEC 60034, NEMA MG 1.22, ISO 8528, CSA/UL on request, marine regulations, etc.

It can be integrated into a CE marked generator.

The LSA 50.2 is designed, manufactured and marketed in an ISO 9001 environment.

TOP OF THE RANGE ELECTRICAL PERFORMANCE

- Class H insulation.
- Standard 6-wire re-connectable winding, 2/3 pitch, type no. 6S.
- Voltage range 50 Hz : 380V - 400V - 415V - 440 V and 220V - 230V - 240V ,
- Voltage range 60 Hz : 380V - 416V - 440V - 480V and 220 V - 240 V.
- High efficiency and motor starting capacity.
- Other voltages are possible with optional adapted windings :
 - 50 Hz : 440 V (no. 7S), 500 V (no. 9S), 600 V (no. 22S or 23S), 690 V (no. 10S or 52S)
 - 60 Hz : 380 V and 416 V (no. 8S), 600 V (no. 9S).
- THD Total harmonic distortion < 3.5% (full load)..
- R 791 interference suppression conforming to standard EN 55011 group 1 class B standard for European zone (CE marking).

EXCITATION AND REGULATION SYSTEM SUITED TO THE APPLICATION

The LSA 50.2 can be supplied with AREP or PMG excitation system, according to the alternator specification.

Excitation system			Regulation options				
Volage regulator	AREP	PMG	T.I. Current transformer for paralleling	R 726 Mains paralleling	R 731 3 Phase sensing	R 734 3 Phase sensing for mains paralleling unbalanced	P Remote voltage potentiometer
R 450	Std	Option	√	√	√	√	√
D 510	Option	Option	√	included	included	contact factory	√

Voltage regulator accuracy +/- 0.5%. √ : possible mounting

PROTECTION SYSTEM SUITED TO THE ENVIRONMENT

- The LSA 50.2 is IP 23.
- Standard winding protection for clean environments with relative humidity ≤ 95 %, including indoor marine environments.
- Options: - Filters on air inlet : derating 5%.
 - Filters on air inlet and air outlet (IP 44) : derating 10%.
 - Winding protections for harsh environments and relative humidity greater than 95%.
 - Space heaters.
 - Thermal protection for winding.

REINFORCED MECHANICAL STRUCTURE USING FINITE ELEMENT MODELLING

- Compact and rigid assembly to better withstand generator vibrations.
- Steel frame.
- Cast iron flanges and shields.
- Twin-bearing and single-bearing versions designed to be suitable for engines on the market.
- Half-key balancing.
- Sealed for life ball bearings, regreasable bearings (optional).
- Standard direction of rotation : clockwise when looking at the drive end view (for anti-clockwise, derate the machine by 5%).

ACCESSIBLE TERMINAL BOX PROPORTIONED FOR OPTIONAL EQUIPMENT

- Easy access to the voltage regulator and to the connections.
- Possible inclusion of accessories for paralleling, protection and measurement.
- Connection bars for winding reconnection.

Copyright 2004 : MOTEURS LEROY-SOMER

Products and materials shown in this catalogue may, at any time, be modified in order to follow the latest technological developments, improve the design or change conditions of utilization. Their description cannot, in any case, engage LEROY-SOMER liability. The values indicated are typical values.

Common data

Insulation class	H	Excitation system	A R E P or PMG
Winding pitch	2/3 (n° 6S)	A.V.R. model	R 450
Terminals	6	Voltage regulation (*)	± 0,5 %
Drip proof	IP 23	Sustained short-circuit current	300% (3 IN) : 10s
Altitude	≤ 1000 m	Totale Harmonic distortion THD (**)	< 3.5 %
Overspeed	2250 mn-1	Waveform : NEMA = TIF (**)	< 50
Air flow	1,8 m³/s (50 Hz) - 2,2 m³/s (60 Hz)		

(*) Steady state duty. (**) Total harmonic distortion content line to line, at no load or full rated linear and balanced load.

Ratings 50 Hz - 1500 R.P.M.

kVA / kW - P.F. = 0,8																	
Duty / T° C		Continuous duty / 40 °C								Stand-by / 40 °C				Stand-by / 27 °C			
Class / T° K		H / 125° K				F / 105° K				H / 150° K				H / 163° K			
Phase		3 ph.				3 ph.				3 ph.				3 ph.			
Y		380V	400V	415V	440V	380V	400V	415V	440V	380V	400V	415V	440V	380V	400V	415V	440V
Δ		220V	230V	240V		220V	230V	240V		220V	230V	240V		220V	230V	240V	
LSA 50.2 S4	kVA	1040	1040	1040	1040	940	940	940	940	1095	1095	1095	1095	1145	1145	1145	1145
	kW	832	832	832	832	752	752	752	752	876	876	876	876	916	916	916	916
LSA 50.2 M6	kVA	1250	1250	1250	1190	1125	1125	1125	1095	1315	1315	1315	1275	1375	1375	1375	1330
	kW	1000	1000	1000	952	900	900	900	876	1052	1052	1052	1020	1100	1100	1100	1064
LSA 50.2 L7	kVA	1350	1350	1350	1260	1215	1215	1215	1150	1420	1420	1420	1365	1485	1485	1485	1425
	kW	1080	1080	1080	1008	972	972	972	920	1136	1136	1136	1092	1188	1188	1188	1140
LSA 50.2 L8	kVA	1450	1500	1500	1440	1320	1350	1350	1320	1520	1575	1575	1555	1595	1650	1650	1625
	kW	1160	1200	1200	1152	1056	1080	1080	1056	1216	1260	1260	1244	1276	1320	1320	1300
LSA 50.2 VL10	kVA	1600	1640	1600	1545	1455	1475	1455	1420	1680	1720	1680	1670	1760	1800	1760	1730
	kW	1280	1312	1280	1236	1164	1180	1164	1136	1344	1376	1344	1336	1408	1440	1408	1384

Ratings 60 Hz - 1800 R.P.M.

kVA / kW - P.F. = 0,8																	
Duty / T° C		Continuous duty / 40 °C								Stand-by / 40 °C				Stand-by / 27 °C			
Class / T° K		H / 125° K				F / 105° K				H / 150° K				H / 163° K			
Phase		3 ph.				3 ph.				3 ph.				3 ph.			
Y		380V	416V	440V	480V	380V	416V	440V	480V	380V	416V	440V	480V	380V	416V	440V	480V
Δ		220V	240V			220V	240V			220V	240V			220V	240V		
LSA 50.2 S4	kVA	1085	1185	1235	1300	975	1065	1110	1170	1140	1245	1300	1365	1195	1300	1360	1430
	kW	868	948	988	1040	780	852	888	936	912	996	1040	1092	956	1040	1088	1144
LSA 50.2 M6	kVA	1285	1405	1455	1560	1155	1265	1310	1405	1350	1475	1530	1640	1410	1545	1600	1720
	kW	1028	1124	1164	1250	924	1012	1048	1124	1080	1180	1224	1312	1128	1236	1280	1376
LSA 50.2 L7	kVA	1375	1500	1555	1680	1240	1350	1400	1510	1440	1575	1630	1765	1510	1650	1710	1850
	kW	1100	1200	1244	1344	992	1080	1120	1208	1152	1260	1304	1412	1208	1320	1368	1480
LSA 50.2 L8	kVA	1485	1625	1720	1875	1335	1460	1550	1685	1560	1705	1805	1965	1630	1785	1890	2060
	kW	1188	1300	1376	1500	1068	1168	1240	1350	1250	1364	1444	1572	1304	1428	1512	1650
LSA 50.2 VL10	kVA	1635	1785	1860	2000	1470	1605	1675	1800	1715	1875	1950	2100	1800	1965	2050	2200
	kW	1308	1428	1488	1600	1176	1284	1340	1440	1372	1500	1560	1680	1440	1572	1640	1760

Efficiencies 50 Hz - P. F. : 1 / P.F. : 0,8

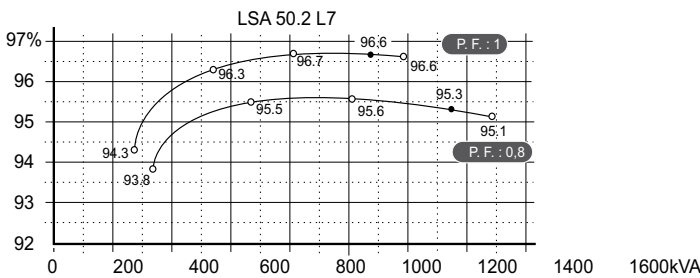
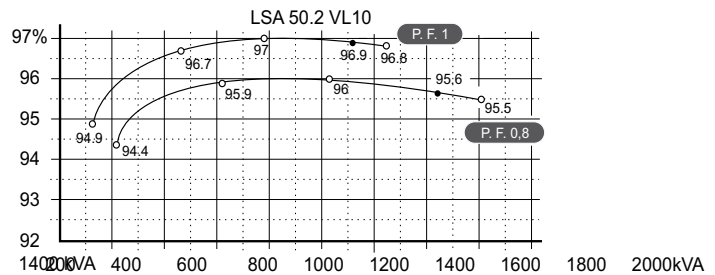
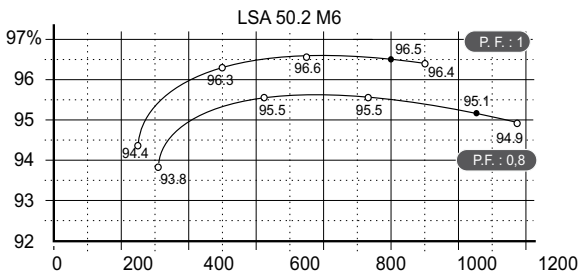
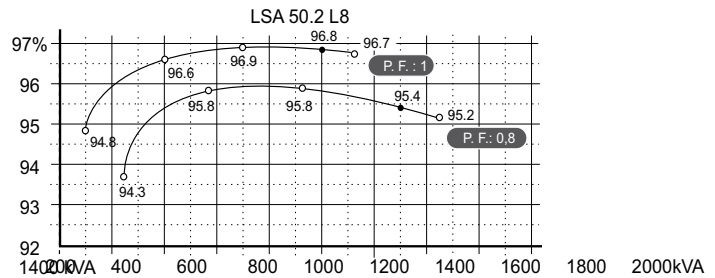
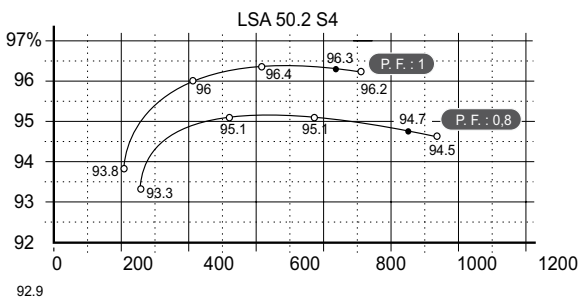

Reactances (%) . Time constants (ms) - Class H / 400 V

	S4	M6	L7	L8	VL10
Kcc Short-circuit ratio	0,30	0,31	0,34	0,31	0,33
Xd Direct axis synchro.reactance unsaturated	394	392	364	378	362
Xq Quadra. axis synchr.reactance unsaturated	236	235	218	227	217
T'do Open circuit time constant	3411	3634	3750	3910	4058
X'd Direct axis transient reactance saturated	20,8	19,4	17,4	17,4	16
T'd Short-Circuit transient time constant	180	180	180	180	180
X''d Direct axis subtransient reactance saturated	17,6	16,5	14,8	14,8	13,6
T''d Subtransient time constant	18	18	18	18	18
X''q Quadra. axis subtransient reactance saturated	18,6	17,3	15,5	15,4	14,2
Xo Zero sequence reactance unsaturated	3,7	3,6	3,6	3,3	3,1
X2 Negative sequence reactance saturated	18,2	16,9	15,2	15,1	13,9
Ta Armature time constant	27	27	27	27	27

Other data - Class H / 400 V

io (A) No load excitation current	0,9	0,9	1,0	0,9	0,9
ic (A) Full load excitation current	4,0	4,1	4,0	3,9	3,7
uc (V) Full load excitation voltage	44	44	44	42	41
ms Recovery time ($\Delta = 20\%$ trans.)	500	500	500	500	500
kVA Motor start. ($\Delta = 20\%$ sust.) or ($\Delta = 50\%$ trans.)	2383	2895	3181	3701	4248
% Transient dip (rated step load) - PF : 0,8 LAG	14,2	13,5	12,4	12,4	11,7
W No load losses	12830	13960	15260	15420	16520
W Heat rejection	45880	51240	53260	57110	59020

Transient voltage variation 400V - 50 Hz

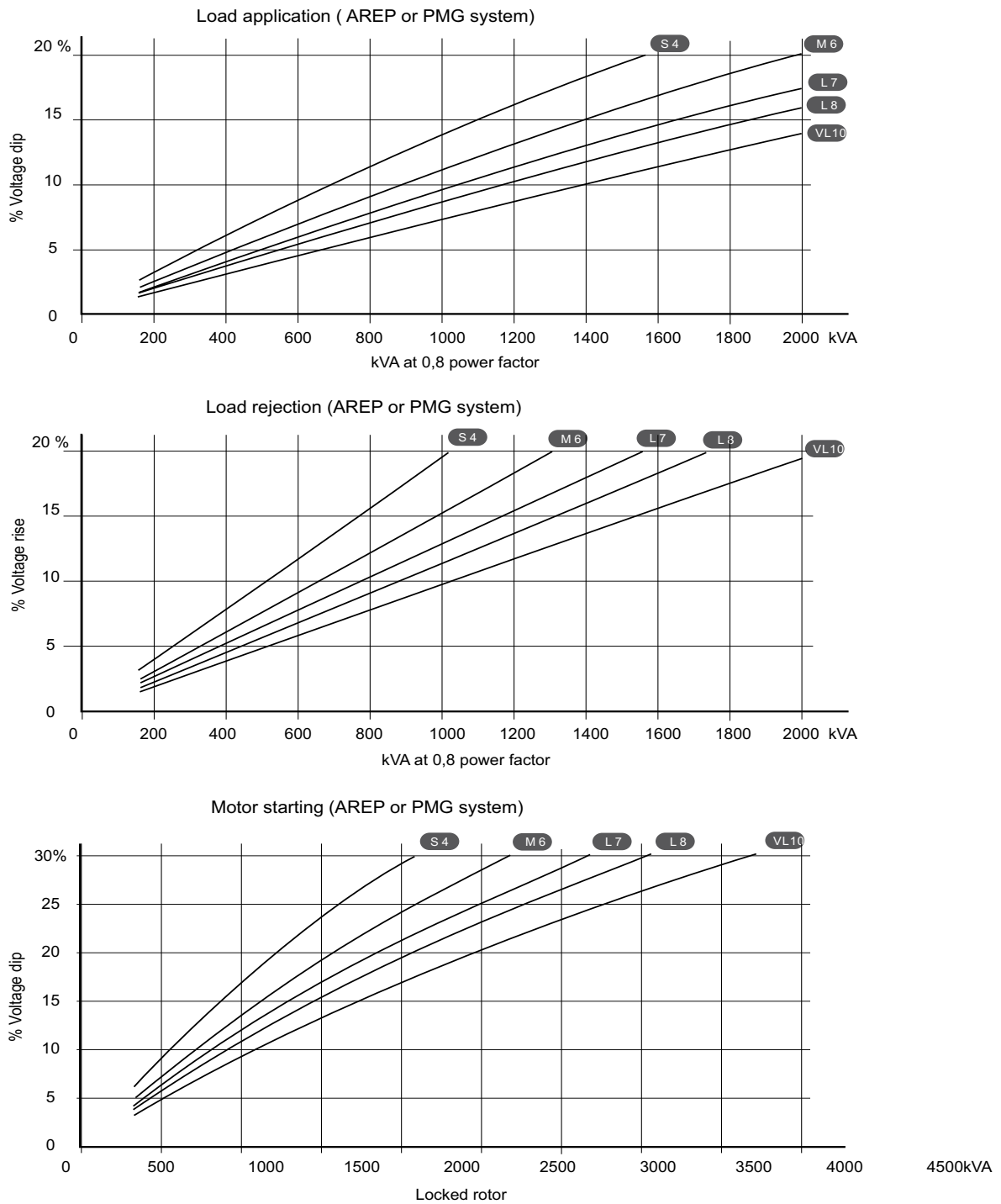

- 1) For a starting P.F. differing from 0,6, the starting kVA must be multiplied by $(\text{Sine } \varnothing / 0,8)$
- 2) For voltages other than 400 V (Y) , 230 V () at 50 Hz , then kVA must be multiplied by $(400/U)^2$ ou $(230/U)^2$

Efficiencies 60 Hz - P. F. : 1 / P. F. : 0,8

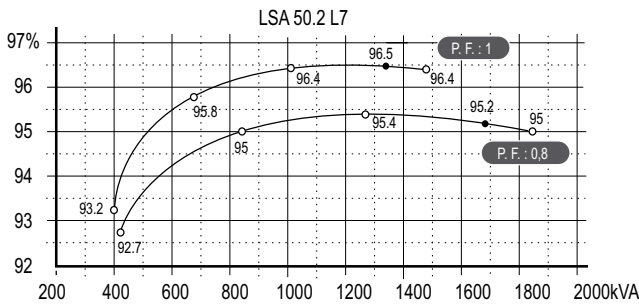
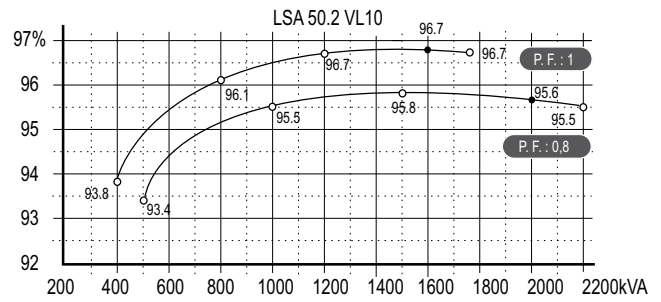
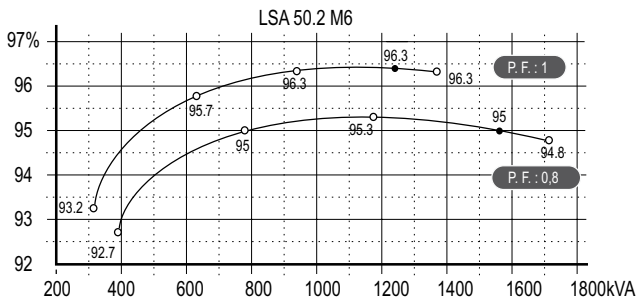
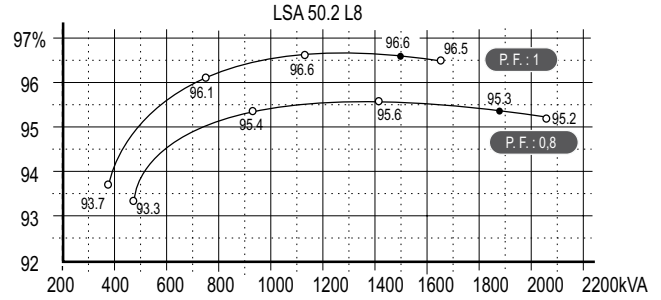
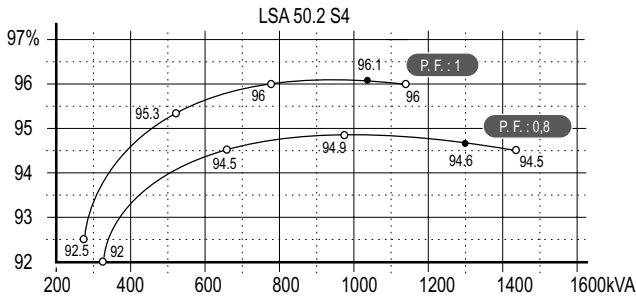

Reactances (%) . Time constants (ms) - Class H / 480 V

	S4	M6	L7	L8	VL10
Kcc Short-circuit ratio	0,29	0,29	0,33	0,30	0,32
Xd Direct axis synchro.reactance unsaturated	410	407	377	394	368
Xq Quadra. axis synchr.reactance unsaturated	246	244	226	236	220
T'do Open circuit time constant	3411	3634	3750	3910	4058
X'd Direct axis transient reactance saturated	21,6	20,2	18,1	18,1	16,3
T'd Short circuit transient time constant	180	180	180	180	180
X''d Direct axis subtransient reactance saturated	18,4	17,1	15,4	15,4	13,8
T''d Subtransient time constant	18	18	18	18	18
X''q Quadra. axis subtransient reactance saturated	19,4	18,0	16,1	16,1	14,4
Xo Zero sequence reactance unsaturated	3,9	3,7	3,7	3,5	3,1
X2 Negative sequence reactance saturated	18,9	17,6	15,8	15,8	14,2
Ta Armature time constant	27	27	27	27	27

Other data - Class H / 480 V

io (A) No load excitation current	0,9	0,9	1,0	0,9	0,9
ic (A) Full load excitation current	4,1	4,2	4,1	4,0	3,7
uc (V) Full load excitation voltage	46	46	45	44	41
ms Recovery time ($\Delta = 20\%$ trans.)	500	500	500	500	500
kVA Motor start. ($\Delta = 20\%$ sust.) or ($\Delta = 50\%$ trans.)	2937	3553	3927	4593	5281
% Transient dip (rated step load) - PF : 0,8 LAG	14,7	13,9	12,8	12,8	11,8
W No load losses	20410	22000	23820	24080	25640
W Heat rejection	58310	64830	67290	72430	72720

Transient voltage variation 480V - 60 Hz

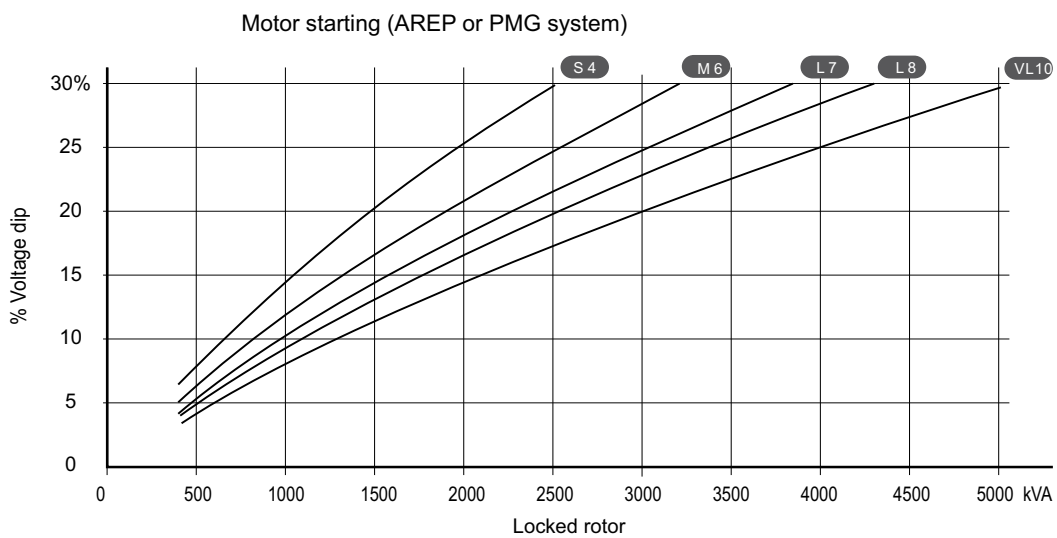
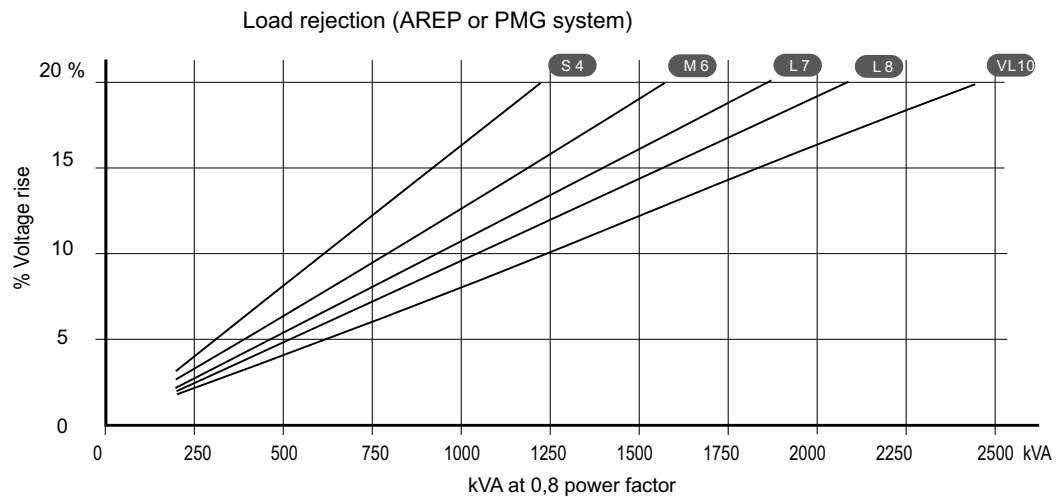
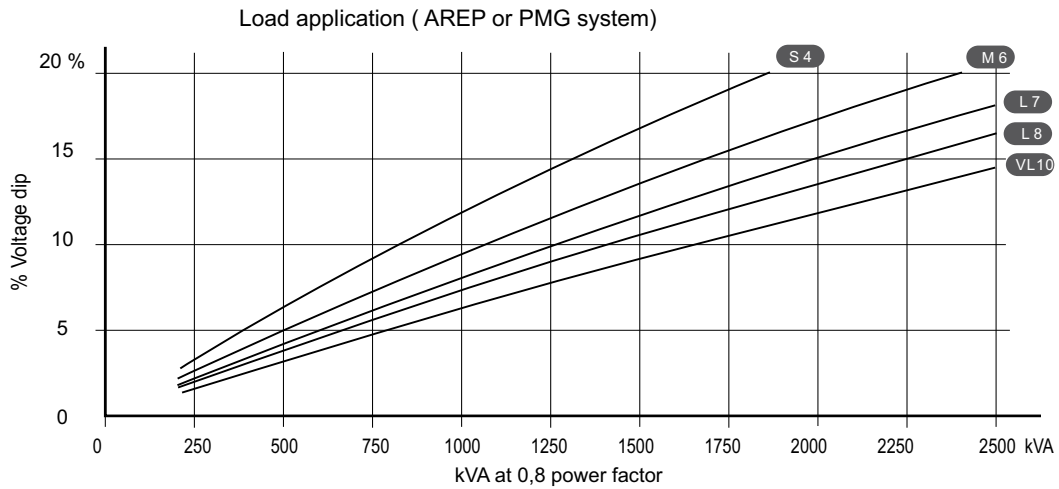

- 1) For a starting P.F. other than 0,6 , the starting kVA must be multiplied by $(\text{Sine } \varnothing / 0,8)$.
- 2) For voltages other than 480 V (Y) $\Delta 277$ V (), 240 V (YY) at 60 Hz , then, kVA must be multiplied by $(480 / U)^2$ or $(277 / U)^2$ or $(240/U)^2$

3 Phase short-circuit curves at no load and rated speed (star connection Y)

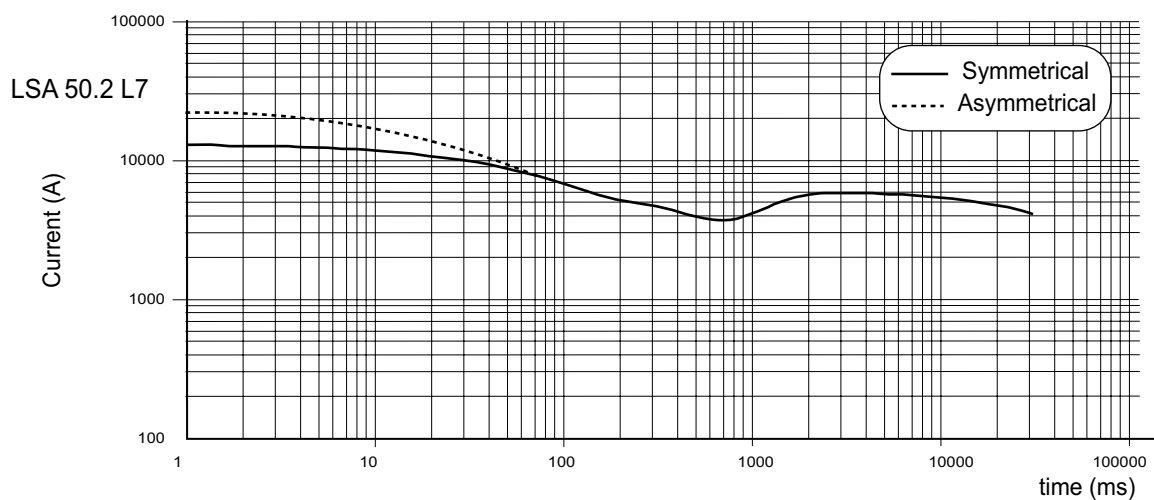
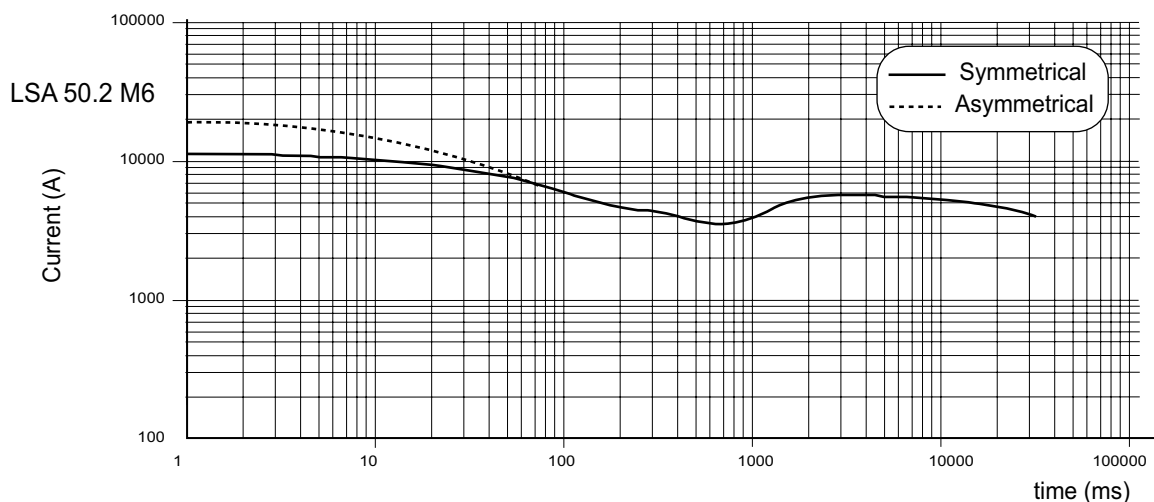
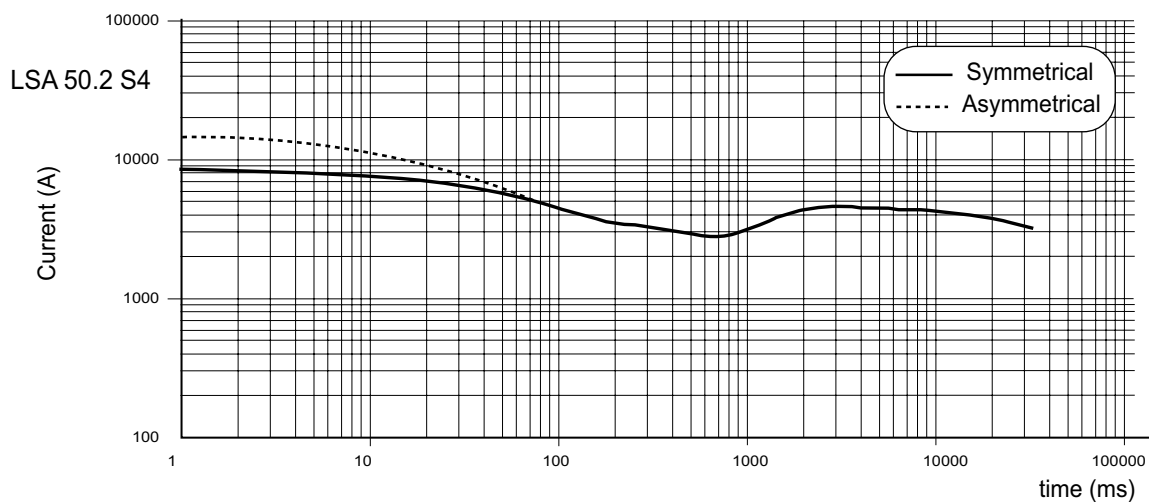

Influence due to connexion

Curves shown are for star connection (Y).

For other connections, use the following multiplication factors :

- Series delta : Current value x 1,732
- Parallel star : Current value x 2

3 Phase short-circuit curves at no load and rated speed (star connection Y)

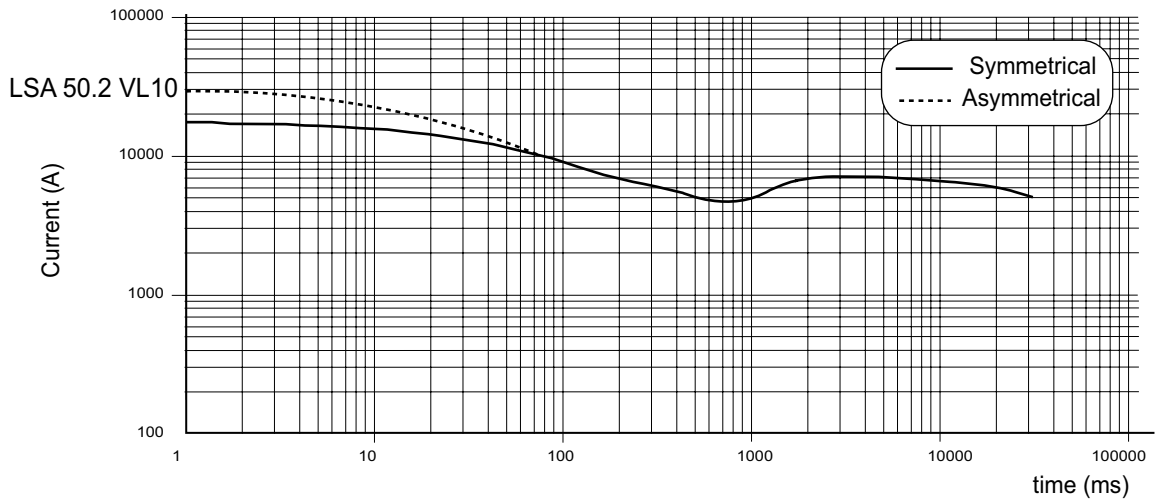
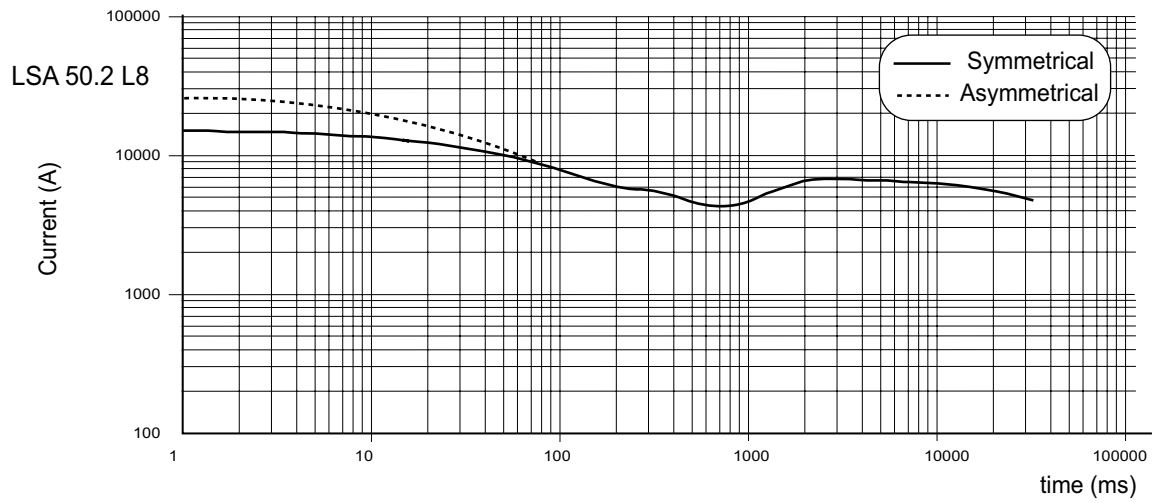

Influence due to short-circuit.

Curves are based on a three-phase short-circuit.

For other types of short-circuit, use the following multiplication factors :

	3 phase	2 phase L - L.	1 phase L - N.
Instantaneous (Max)	1	0,87	1,3
Sustained	1	1,5	2,2
Max sustained duration (AREP/ PMG)	10 sec.	5 sec.	2 sec.

Single bearing dimensions

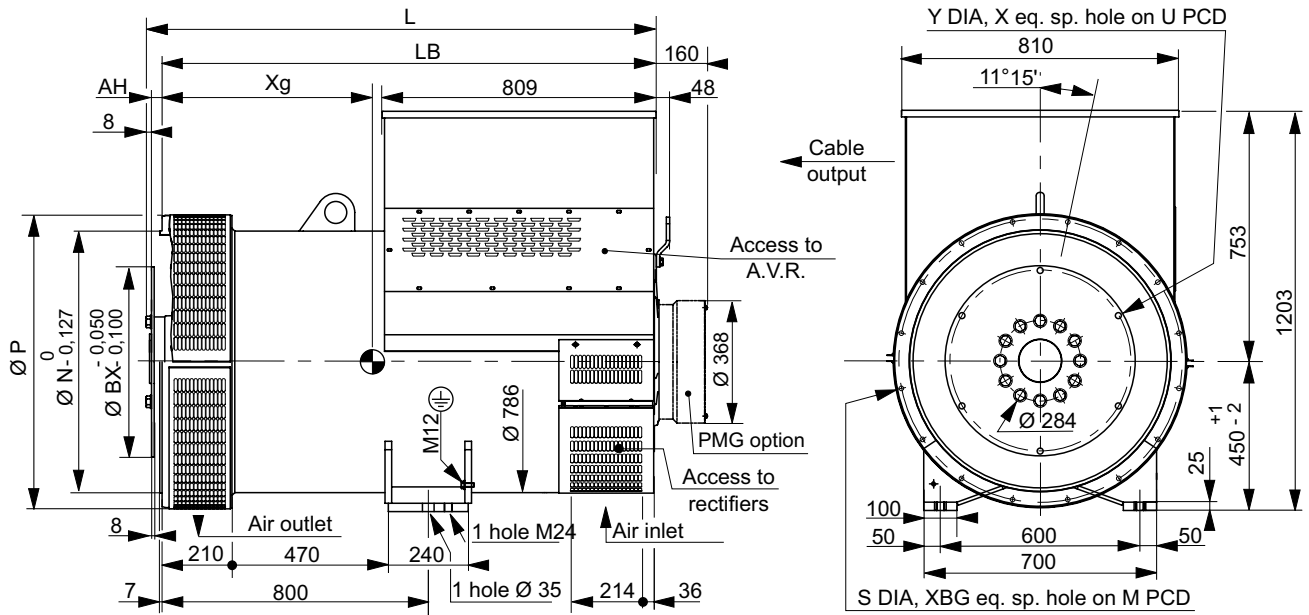

Frame dimensions (mm) and weight (kg)

TYPE	L without PMG	LB	Xg	Weight (kg)
LSA 50.2 S4	1302	1278	620	2290
LSA 50.2 M6	1402	1378	640	2490
LSA 50.2 L7	1502	1478	690	2760
LSA 50.2 L8	1502	1478	710	2980
LSA 50.2 VL10	1602	1578	760	3260

Coupling

	Flex plate	18	21
Flange S.A.E 0	X		
Flange S.A.E 00	X	X	

Flange dimensions (mm)

S.A.E.	P	N	M	XBG	S
0	880	647.7	679.5	16	14
00	880	787.4	850.9	16	14

Flex plate dimensions (mm)

S.A.E.	BX	U	X	Y	AH
21	673.1	641.3	12	18	0
18	571.5	542.9	6	18	15.7

Torsional analysis data

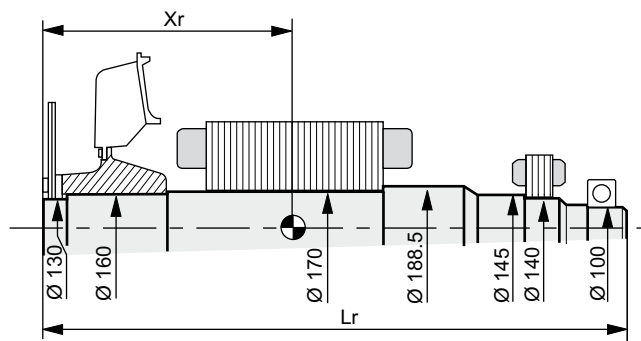

Centre of gravity : Xr (mm), rotor length Lr (mm), Weight : M (kg), Moment of inertia : J (kgm²) : (4J = MD²)

TYPE	Xr	Flex plate S.A.E. 18			Xr	Flex plate S.A.E. 21		
		Lr	M	J		Lr	M	J
LSA 50.2 S4	564	1320.5	833	18.17	549	1320.5	831	18.62
LSA 50.2 M6	608	1420.5	934	20.6	593	1420.5	932	21.09
LSA 50.2 L7	643	1520.5	1005	22.23	627	1520.5	1003	22.68
LSA 50.2 L8	667	1520.5	1082	24.6	652	1520.5	1081	25.05
LSA 50.2 VL 10	714	1620.5	1192	27.27	698	1620.5	1191	27.72

Two bearing dimensions

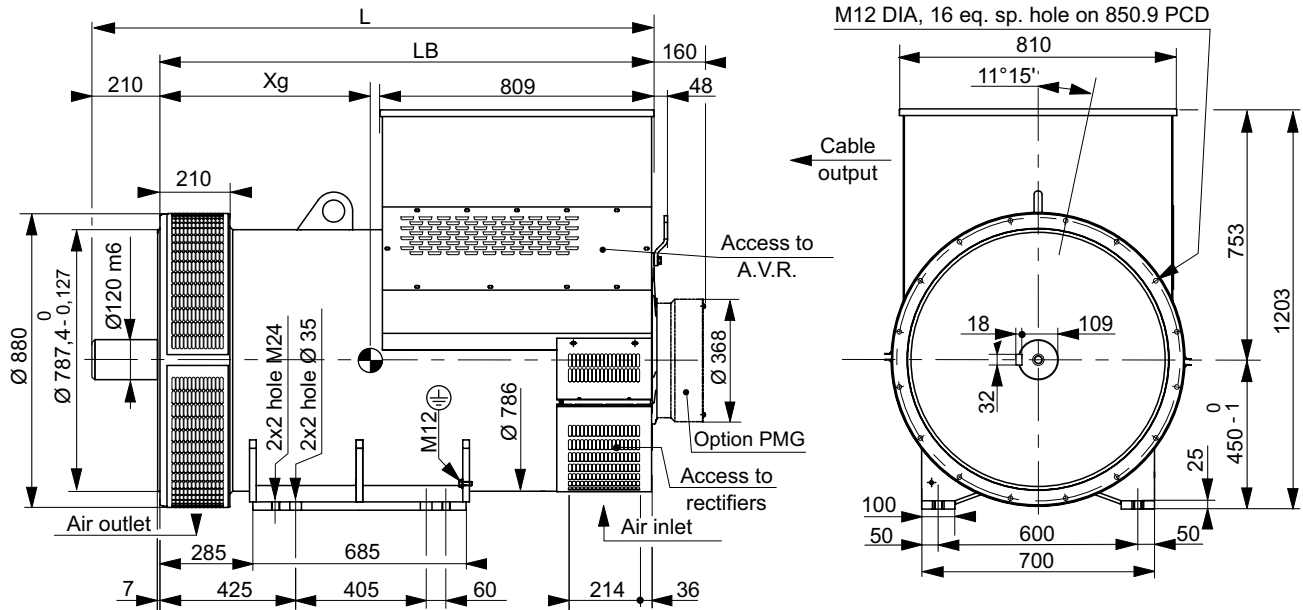

Frame dimensions (mm) and weight (kg)

TYPE	L without PMG	LB	Xg	Weight (kg)
LSA 50.2 S4	1488	1278	600	2330
LSA 50.2 M6	1588	1378	620	2530
LSA 50.2 L7	1688	1478	670	2800
LSA 50.2 L8	1688	1478	690	3010
LSA 50.2 VL10	1788	1578	740	3300

Torsional analysis data

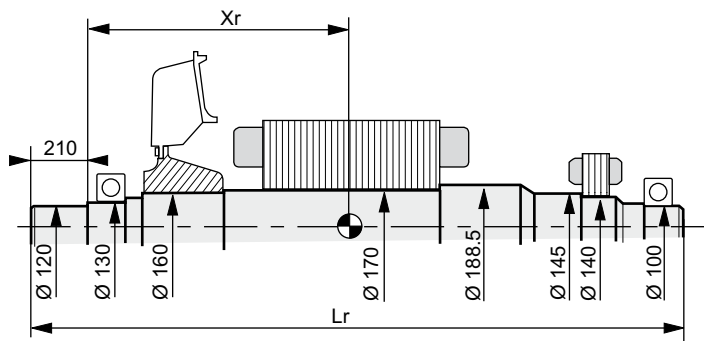

Centre of gravity : Xr (mm), rotor length Lr (mm), Weight : M (kg), Moment of inertia : J (kgm²) : (4J = MD²)

TYPE	Xr	Lr	M	J
LSA 50.2 S4	590	1509	761	16.58
LSA 50.2 M6	632	1609	862	19.05
LSA 50.2 L7	667	1709	932	20.63
LSA 50.2 L8	690	1709	1010	23
LSA 50.2 VL10	736	1809	1120	25.67

Contact

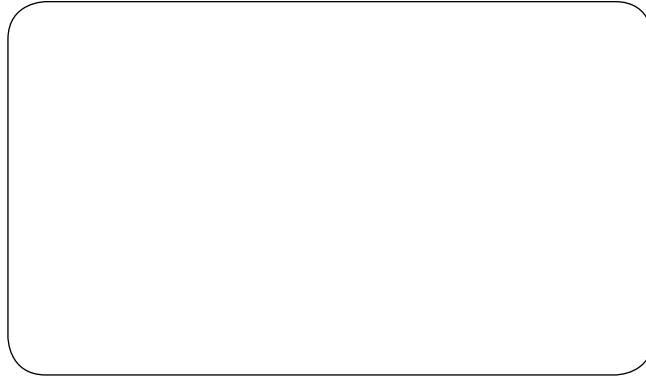

www.leroy-somer.com



**LEROY[®]
SOMER**

EMERSON[™]
Industrial Automation